

Configuration Examples for FAS2220 Systems

NetApp, Inc.
495 East Java Drive
Sunnyvale, CA 94089 U.S.
Telephone: +1 (408) 822-6000
Fax: +1 (408) 822-4501
Support telephone: +1 (888) 463-8277
Web: www.netapp.com
Feedback: doccomments@netapp.com

Part number: 215-07214_A0
September 2012

Contents

FAS2220 configuration options	4
Example 1: HA pair with no external disk shelves	5
Example 2: HA pair with external SAS shelves	6
Example 3: HA pair with SAS tape backup	7
Example 4: HA pair with external SAS shelves and tape backup	8
Example 5: Stand-alone controller with SAS shelves (single-path)	9
Example 6: Stand-alone controller with SAS shelves (dual-path)	10
Example 7: Stand-alone controller with SAS shelves (single-path) and tape backup	12
Copyright information	14
Trademark information	15
How to send your comments	16

FAS2220 configuration options



The FAS2220 systems can be used in a variety of physical configurations and with different storage protocols.

Configuration	Possible variations
Storage protocol	<ul style="list-style-type: none"> NFS, CIFS, and/or iSCSI
Controller resiliency	<ul style="list-style-type: none"> HA pair The system has two redundant controller modules. Stand-alone configuration The system has one controller module.
Internal/external storage	<ul style="list-style-type: none"> Internal disks Internal disks in the system chassis are used. External SAS disks or tape
Disk shelf connection redundancy	<ul style="list-style-type: none"> Multipath configuration The controller has multiple connections to disks on the disk shelves. Multipath is the preferred configuration. Dual-path configuration The controller has two connections to disks on the disk shelves. Single-path configuration The disk shelves have a single connection to the controller. This configuration is not preferred but is supported on entry level platforms.
Backup device	<p>External backup devices</p> <p>The system connects to a tape backup device.</p>

Example 1: HA pair with no external disk shelves

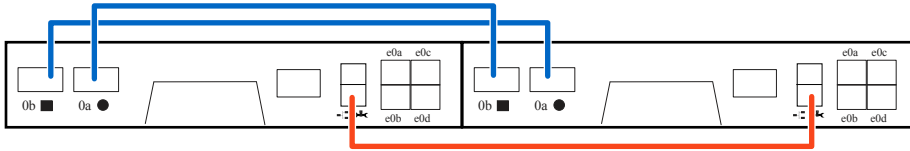
The FAS2220 systems can be configured as an HA pair with no external disk drives.





	The red cables are Ethernet ACP connections.
	The blue cables are SAS disk shelf connections.

Configuration details	Configuration used
Storage protocol	NFS, CIFS, and/or iSCSI
Controller resiliency	HA pair
Internal/external storage	Internal only
Disk shelf connection redundancy	Multipath HA Note: This is the recommended configuration. If the external cables are not used, the internal drives have single-path connectivity. Such a configuration is supported but not recommended.
Backup device	None

Example 2: HA pair with external SAS shelves

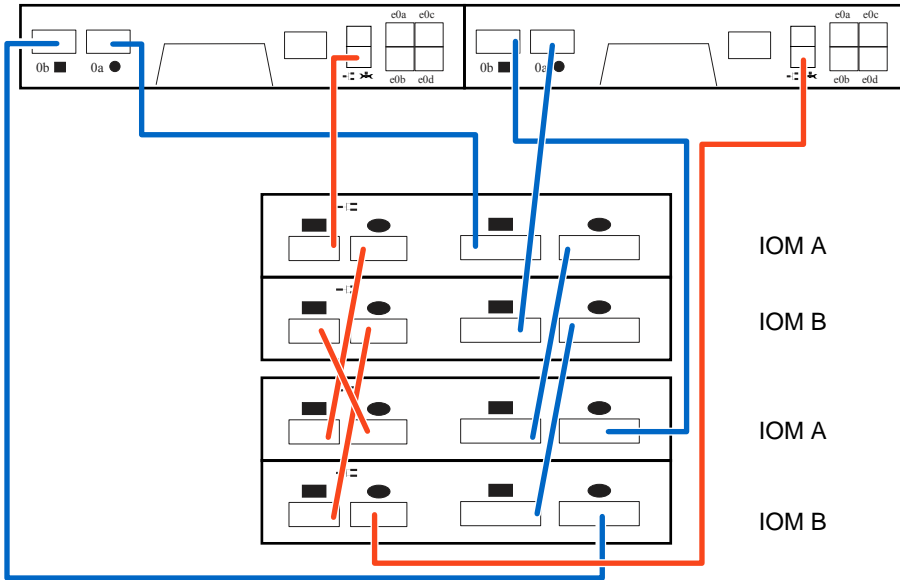
The FAS2220 systems can be configured as an HA pair with external SAS disk shelves.



	The red cables are Ethernet ACP connections.
	The blue cables are SAS disk shelf connections.

Configuration details	Configuration used
Storage protocol	NFS, CIFS, iSCSI
Controller resiliency	HA pair
External storage	External SAS disk shelves
Disk shelf connection redundancy	Multipath HA
Backup device	None



If you have SSD shelves

If you have SAS disk shelves with SSDs, the shelves with the SSDs should be the last shelves in the stack and connect to the 0b port on each controller.

Example 3: HA pair with SAS tape backup

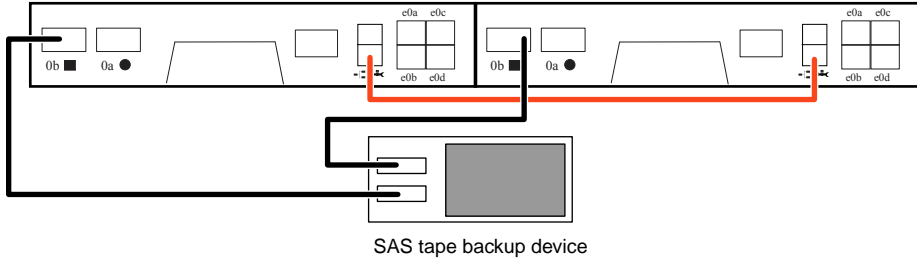
The FAS2220 systems can be configured as an HA pair with an external SAS tape backup device.







	The red cables are Ethernet ACP connections.
	The black cables are SAS tape drive connections.

Configuration details	Configuration used
Storage protocol	NFS, CIFS, and/or iSCSI
Controller resiliency	HA pair
External storage	Internal only
Disk shelf connection redundancy	n/a
Backup device	SAS tape backup device

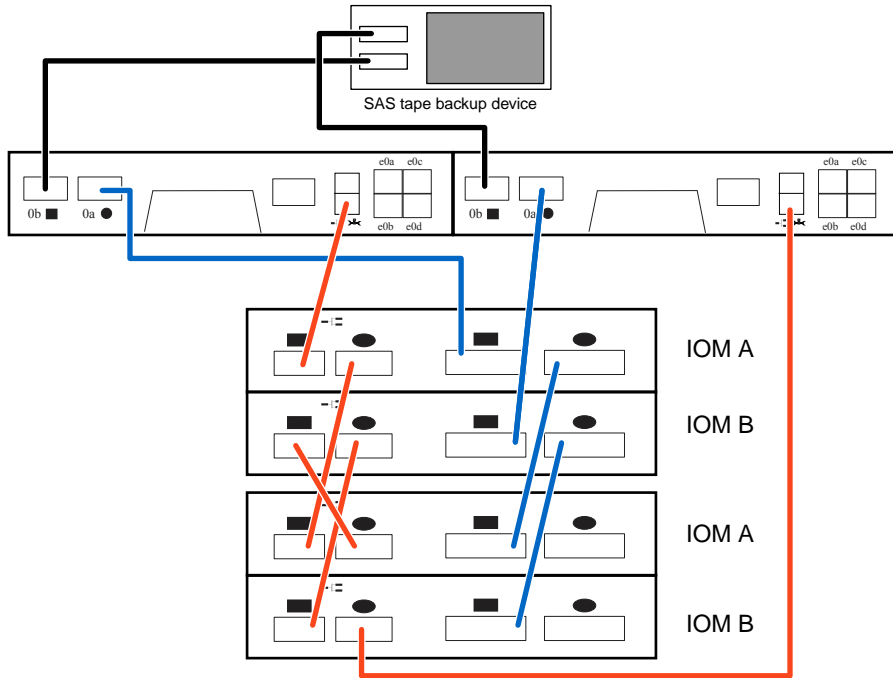
Example 4: HA pair with external SAS shelves and tape backup

The FAS2220 systems can be configured as an HA pair connected to external SAS disk shelves and a SAS tape backup device.



	The red cables are Ethernet ACP connections.
	The blue cables are SAS disk shelf connections.
	The black cables are SAS tape drive connections.



Configuration details	Configuration used
Storage protocol	NFS, CIFS, iSCSI
Controller resiliency	HA pair
External storage	External SAS
Disk shelf connection redundancy	Single-path
Backup device	Single-path SAS tape backup device

Example 5: Stand-alone controller with SAS shelves (single-path)

The FAS2220 systems can be configured as stand-alone controllers with an external stack of SAS disk shelves, with single-path connectivity. Although the single-path connections provide less resiliency than a dual-path configuration, Data ONTAP does not display the intermittent alert messages that appear when a dual-path configuration is used.

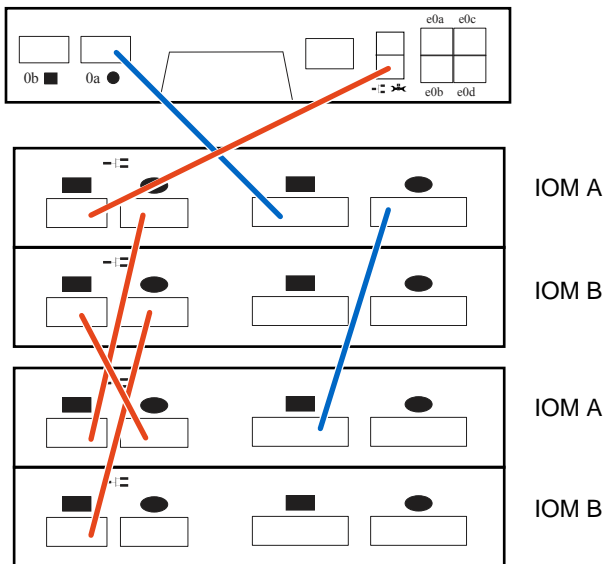
Note: This configuration is not recommended for shelves with SSDs.



	The red cables are Ethernet ACP connections.
	The blue cables are SAS disk shelf connections.



Configuration details	Configuration used
Storage protocol	NFS, CIFS, iSCSI
Controller resiliency	Stand-alone
External storage	External SAS disk shelves
Disk shelf connection redundancy	Single-path
Backup device	None

Example 6: Stand-alone controller with SAS shelves (dual-path)

The FAS2220 system can be configured as a stand-alone controller with dual-path connectivity to external SAS storage. This configuration provides more resiliency than the single-path configuration, but Data ONTAP displays intermittent alert messages that the system is in a mixed-path configuration.

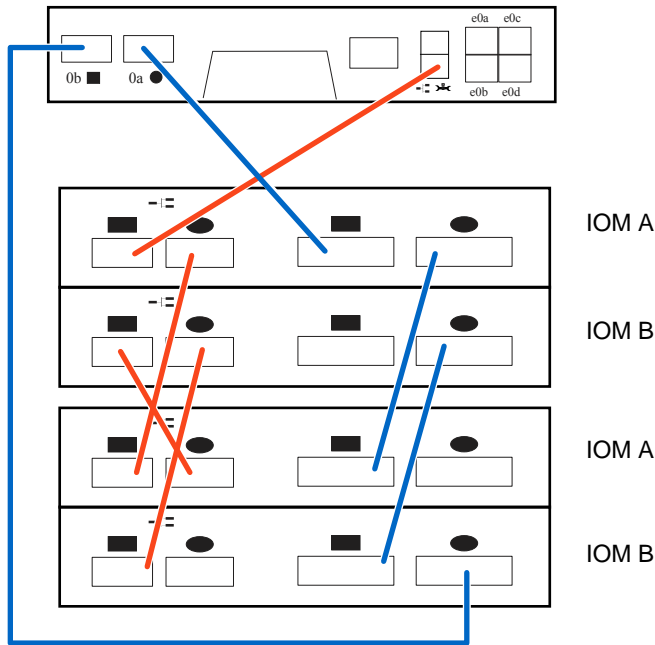
Note: This configuration is not recommended for shelves with SSDs. If you have SAS disk shelves with SSDs, the shelves with the SSDs should be the last shelves in the stack and connect to the 0b port on each controller.



	The red cables are Ethernet ACP connections.
	The blue cables are SAS disk shelf connections.



Configuration details	Configuration used
Storage protocol	NFS, CIFS, iSCSI
Controller resiliency	Stand-alone
External storage	External SAS disk shelves

Configuration details	Configuration used
Disk shelf connection redundancy	Dual-path
Backup device	None

Example 7: Stand-alone controller with SAS shelves (single-path) and tape backup

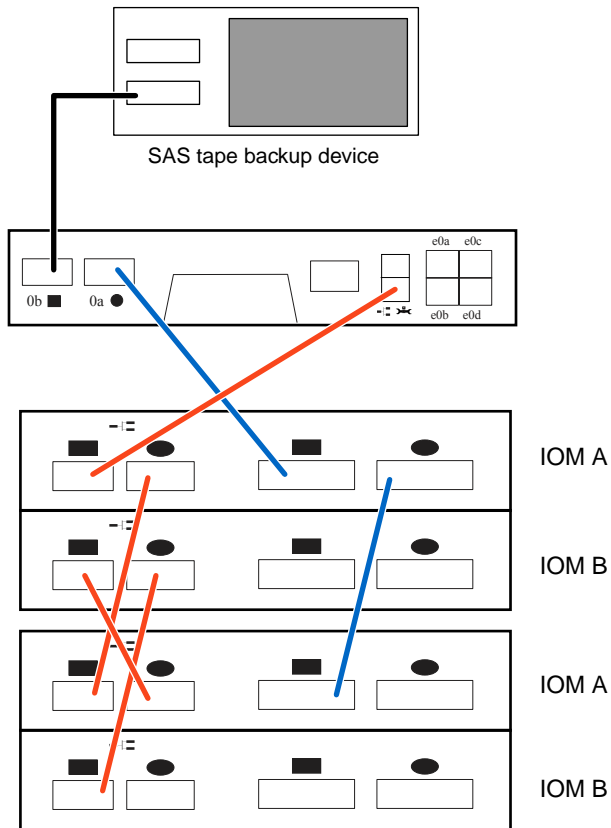
The FAS2220 system can be configured as a stand-alone controller with single-path connections to a stack of SAS disk shelves and a SAS tape backup device.



	The red cables are Ethernet ACP connections.
	The blue cables are SAS disk shelf connections.
	The black cables are SAS tape drive connections.

Configuration details	Configuration used
Storage protocol	NFS, CIFS, iSCSI
Controller resiliency	Stand-alone

Example 7: Stand-alone controller with SAS shelves (single-path) and tape backup | 13

Configuration details	Configuration used
External storage	External SAS disk shelves
Disk shelf connection redundancy	Single-path
Backup device	SAS tape backup device

Copyright information

Copyright © 1994–2012 NetApp, Inc. All rights reserved. Printed in the U.S.

No part of this document covered by copyright may be reproduced in any form or by any means—graphic, electronic, or mechanical, including photocopying, recording, taping, or storage in an electronic retrieval system—without prior written permission of the copyright owner.

Software derived from copyrighted NetApp material is subject to the following license and disclaimer:

THIS SOFTWARE IS PROVIDED BY NETAPP "AS IS" AND WITHOUT ANY EXPRESS OR IMPLIED WARRANTIES, INCLUDING, BUT NOT LIMITED TO, THE IMPLIED WARRANTIES OF MERCHANTABILITY AND FITNESS FOR A PARTICULAR PURPOSE, WHICH ARE HEREBY DISCLAIMED. IN NO EVENT SHALL NETAPP BE LIABLE FOR ANY DIRECT, INDIRECT, INCIDENTAL, SPECIAL, EXEMPLARY, OR CONSEQUENTIAL DAMAGES (INCLUDING, BUT NOT LIMITED TO, PROCUREMENT OF SUBSTITUTE GOODS OR SERVICES; LOSS OF USE, DATA, OR PROFITS; OR BUSINESS INTERRUPTION) HOWEVER CAUSED AND ON ANY THEORY OF LIABILITY, WHETHER IN CONTRACT, STRICT LIABILITY, OR TORT (INCLUDING NEGLIGENCE OR OTHERWISE) ARISING IN ANY WAY OUT OF THE USE OF THIS SOFTWARE, EVEN IF ADVISED OF THE POSSIBILITY OF SUCH DAMAGE.

NetApp reserves the right to change any products described herein at any time, and without notice. NetApp assumes no responsibility or liability arising from the use of products described herein, except as expressly agreed to in writing by NetApp. The use or purchase of this product does not convey a license under any patent rights, trademark rights, or any other intellectual property rights of NetApp.

The product described in this manual may be protected by one or more U.S. patents, foreign patents, or pending applications.

RESTRICTED RIGHTS LEGEND: Use, duplication, or disclosure by the government is subject to restrictions as set forth in subparagraph (c)(1)(ii) of the Rights in Technical Data and Computer Software clause at DFARS 252.277-7103 (October 1988) and FAR 52-227-19 (June 1987).

Trademark information

NetApp, the NetApp logo, Network Appliance, the Network Appliance logo, Akorri, ApplianceWatch, ASUP, AutoSupport, BalancePoint, BalancePoint Predictor, Bycast, Campaign Express, ComplianceClock, Cryptainer, CryptoShred, Data ONTAP, DataFabric, DataFort, Decru, Decru DataFort, DenseStak, Engenio, Engenio logo, E-Stack, FAServer, FastStak, FilerView, FlexCache, FlexClone, FlexPod, FlexScale, FlexShare, FlexSuite, FlexVol, FPolicy, GetSuccessful, gFiler, Go further, faster, Imagine Virtually Anything, Lifetime Key Management, LockVault, Manage ONTAP, MetroCluster, MultiStore, NearStore, NetCache, NOW (NetApp on the Web), Onaro, OnCommand, ONTAPI, OpenKey, PerformanceStak, RAID-DP, ReplicatorX, SANscreen, SANshare, SANtricity, SecureAdmin, SecureShare, Select, Service Builder, Shadow Tape, Simplicity, Simulate ONTAP, SnapCopy, SnapDirector, SnapDrive, SnapFilter, SnapLock, SnapManager, SnapMigrator, SnapMirror, SnapMover, SnapProtect, SnapRestore, Snapshot, SnapSuite, SnapValidator, SnapVault, StorageGRID, StoreVault, the StoreVault logo, SyncMirror, Tech OnTap, The evolution of storage, Topio, vFiler, VFM, Virtual File Manager, VPolicy, WAFL, Web Filer, and XBB are trademarks or registered trademarks of NetApp, Inc. in the United States, other countries, or both.

IBM, the IBM logo, and ibm.com are trademarks or registered trademarks of International Business Machines Corporation in the United States, other countries, or both. A complete and current list of other IBM trademarks is available on the web at www.ibm.com/legal/copytrade.shtml.

Apple is a registered trademark and QuickTime is a trademark of Apple, Inc. in the United States and/or other countries. Microsoft is a registered trademark and Windows Media is a trademark of Microsoft Corporation in the United States and/or other countries. RealAudio, RealNetworks, RealPlayer, RealSystem, RealText, and RealVideo are registered trademarks and RealMedia, RealProxy, and SureStream are trademarks of RealNetworks, Inc. in the United States and/or other countries.

All other brands or products are trademarks or registered trademarks of their respective holders and should be treated as such.

NetApp, Inc. is a licensee of the CompactFlash and CF Logo trademarks.

NetApp, Inc. NetCache is certified RealSystem compatible.

How to send your comments

You can help us to improve the quality of our documentation by sending us your feedback.

Your feedback is important in helping us to provide the most accurate and high-quality information. If you have suggestions for improving this document, send us your comments by email to doccomments@netapp.com. To help us direct your comments to the correct division, include in the subject line the product name, version, and operating system.

You can also contact us in the following ways:

- NetApp, Inc., 495 East Java Drive, Sunnyvale, CA 94089 U.S.
- Telephone: +1 (408) 822-6000
- Fax: +1 (408) 822-4501
- Support telephone: +1 (888) 463-8277